

# JENSEN® HEAVY DUTY™

## JHD910 Owner's Manual

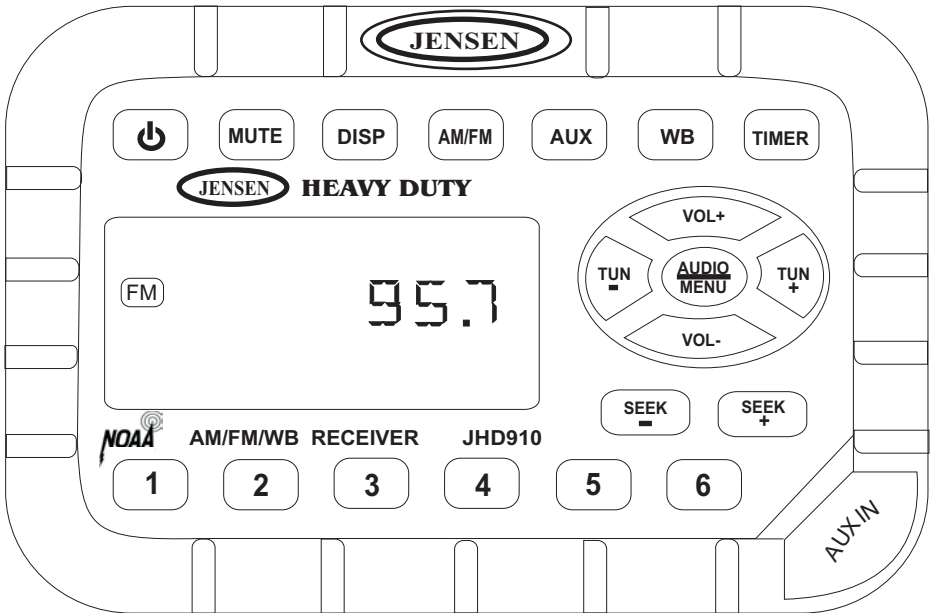



***Thank You!***

Thank you for choosing a Jensen product. We hope you will find the instructions in this owner's manual clear and easy to follow. If you take a few minutes to look through it, you'll learn how to use all the features of your new Jensen receiver for maximum enjoyment.

**System Features** ..... 2

**Installation** ..... 4

**Wiring** ..... 6

**Basic Operation** ..... 7

**Tuner Operation** ..... 9

**Weather Band Operation** ..... 10

**Troubleshooting** ..... 11

**Specifications** ..... 12

***Features***

Features of the Jensen JHD910 mobile audio system include:

- Waterproof
- uV and Corrosion Resistant
- Electronic US/Euro AM/FM Tuner
- 30 Programmable Presets (12 AM, 18 FM)
- Non-Volatile Memory for User Settings and Preset Memories
- 7-Channel NOAA Weather Band
- Weather Alert
- Auxiliary Audio Input
- Headphone Output
- 2-Channel Amplified Audio Output
- Backlit Controls with Selectable Illumination Color
- Daylight Readable Display
- Clock with 30-day Backup Power
- Work Timer
- Audible Beep ConfirmationTone

## Package Contents

- JHD910 Radio
- Radio Mounting Bracket
- Headphone Mounting Bracket
- Five (5) 10-16 x 3/4" Stainless Steel PPH Screws
- Five (5) 10-32 x 5/8" Stainless Steel PPH Screws
- Five (5) 10-32 Stainless Steel Hex Nuts
- Five (5) #10 Stainless Steel Washers
- Four (4) M4 x .7 x 8MM Stainless Steel Hex Screws with Captivated Washers
- Wiring Harness
- Auxiliary Input Patch Cord
- Owner's Manual

## Owner's Manual

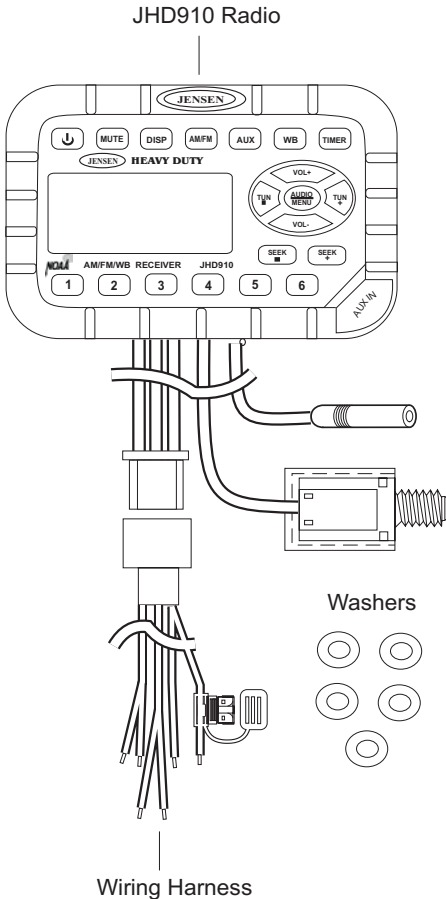

Radio Mounting Bracket

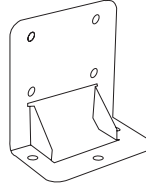

Self-Tapping Screws (3)



Machine Screws with Nuts (3)



M4 Machine Screws (4)



Headphone Mounting Bracket

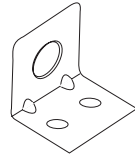

Self-Tapping Screws (2)



Machine Screws with Nuts (2)



Auxiliary Input Patch Cord





## Installation

### Mounting the Bracket

Two options are provided for mounting the bracket (self-tapping screws or machine screws with nuts) to ensure a mounting option ideal for your mounting location. Avoid obstructing airflow to the rear cooling fins on the radio.

**Note: Mounting holes should be drilled to 7/32". Before drilling the mounting holes, make sure the area behind the panel where the holes are desired is clear of wires and fuel, vacuum and or brake lines.**

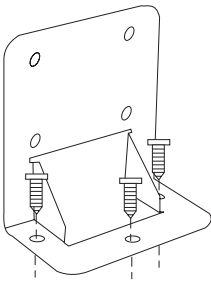

Self-Tapping  
Screws  
(Hole size 7/32")

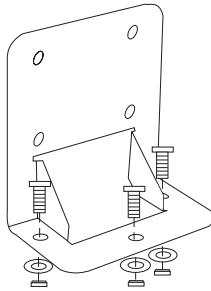

Machine Screws  
with Nuts  
(Hole size 7/32")

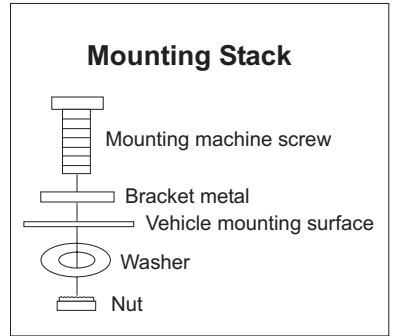

### Attaching the Radio

Once the bracket is securely mounted, use the four included M4 machine screws to fasten the bracket to the back of the radio. Alternately, the radio can be mounted directly to the instrument panel if access to the rear of the instrument panel is available.

Regular  
Mounting

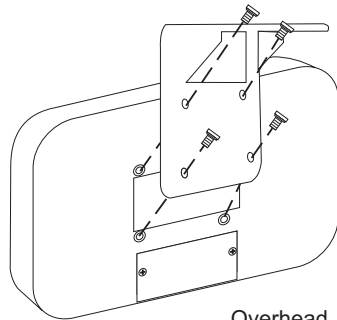
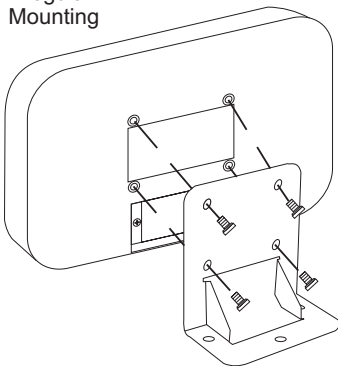

Overhead  
Mounting

## Installation (continued)

### Mounting the Headphone Bracket

Three options are provided for mounting the bracket (self-tapping screws, machine screws with nuts or double-sided tape) to ensure a mounting option ideal for your mounting location. Alternately, the headphone can be mounted directly to the instrument panel if access to the rear of the instrument panel is available.

**Note: Mounting holes should be drilled to 7/32". Before drilling the mounting holes, make sure the area behind the panel where the holes are desired is clear of wires and fuel, vacuum and or brake lines.**

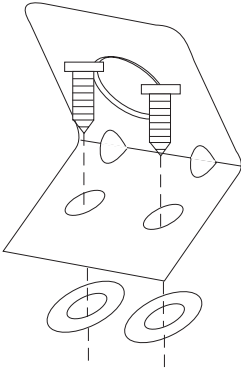

Self-Tapping  
Screws  
(Hole size 7/32")

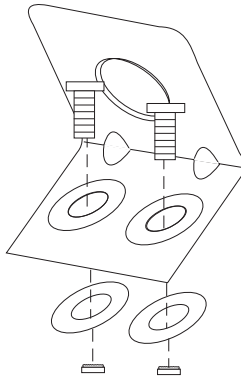

Machine Screws  
with Nuts  
(Hole size 7/32")

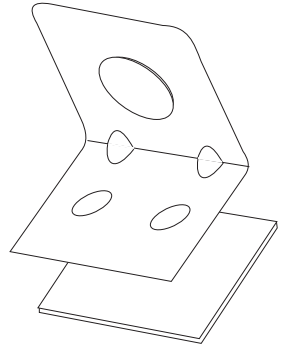

Double-Sided  
Tape

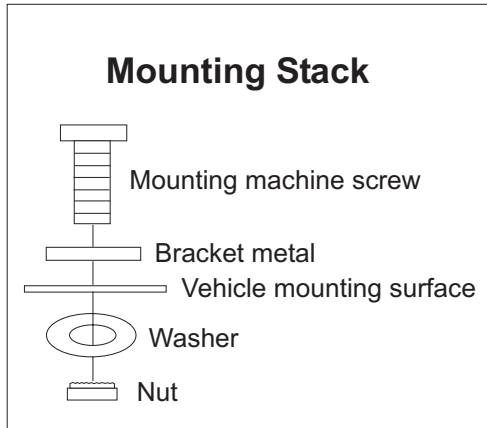



## Wiring

The wiring diagram depicts all the wiring connections required for proper operation of the unit.

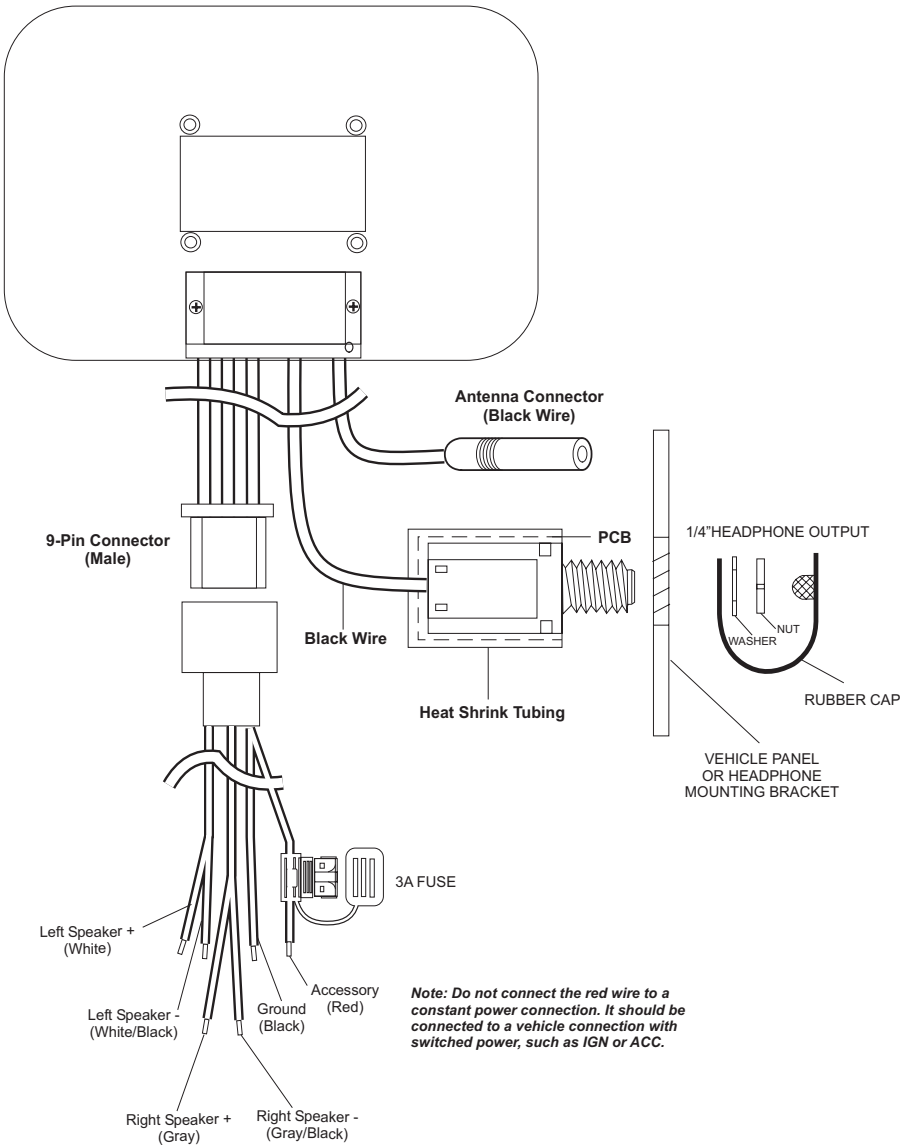

## Basic Operation

### 1. Power

Press the power button (1) momentarily to turn the unit on or off. This button is also used to access the version number of the software. To briefly display the software version on the LCD, press and hold the power button for more than five seconds.

### 2. Mute

Press **MUTE** (2) to silence the audio output in tuner, weather band or auxiliary input mode. When the audio output is silenced, "MUTE" will appear in the display. If the mute feature is activated when the unit is turned off, the volume will default to the programmed turn-on level when the unit is turned back on.

### 3. Display

Press **DISP** (3) momentarily to toggle the LCD display between function mode (showing tuner, auxiliary input or weather band information, depending on which mode is currently activated) and clock mode (showing the time).

### 4. Liquid Crystal Display

The Liquid Crystal Display (LCD) panel (4) displays the frequency, time and activated functions.

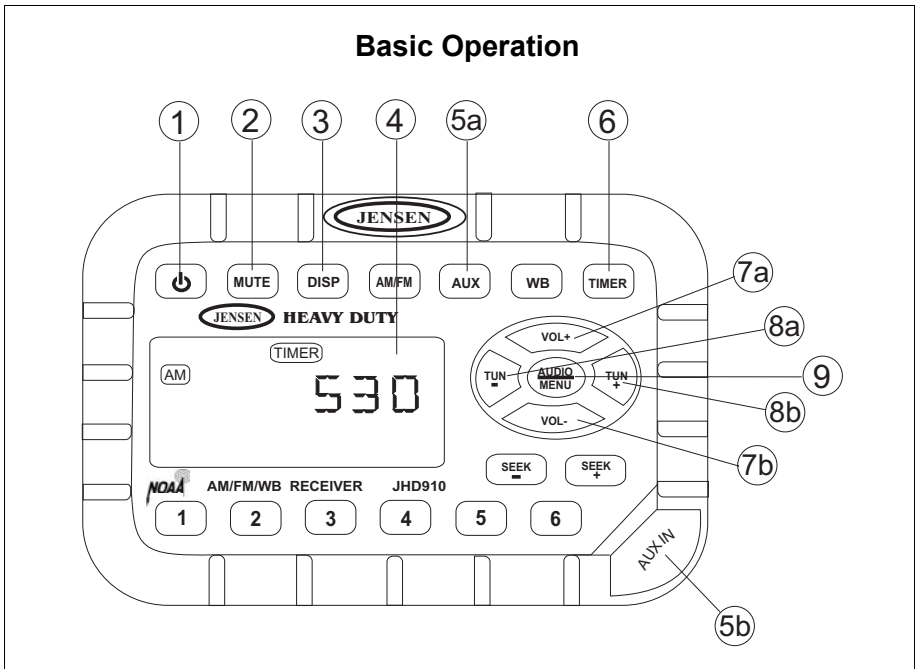



## **5. Auxiliary Input Function**

To connect a portable audio device (MP3 player, iPOD, etc.) to the JHD910, connect the headphone or line level output of the device to the 1/8" auxiliary input jack of the JHD910 (5b) using the audio patch cord (included). Press **AUX** (5a) to select auxiliary input mode.

## **6. Timer**

Press **TIMER** (6) momentarily to directly access timer mode. Briefly press **TIMER** to start the timer function, and the "TIMER" icon will flash in the display. Press **TIMER** again to stop the timer, and the "TIMER" icon will remain in the display (without flashing). Press the button again briefly to resume the timer, or press and hold it for three seconds to reset it to zero and to remove the "Timer" icon from the display.

## **7. Volume**

Briefly press **VOL+** (7a) or **VOL-** (7b) to adjust the volume up or down one step. Press and hold **VOL+** or **VOL-** for more than one second to continuously adjust the volume level until the button is released. The current volume level (0 to 40) will appear in the display when the volume is adjusted, returning to the default display three seconds after the adjustment is complete.

## **8. Setting the Clock**

To set the clock to display the current time, press **DISP** for more than three seconds to enter clock setting mode, and the time will flash in the display. Press **TUN-** (8a) to adjust the hours or **TUN+** (8b) to adjust the minutes. When no adjustment is made for ten seconds, the time will be set and normal operation will resume.

## **9. Audio and Menu Adjustment**

### Audio Adjustment

Press **AUDIO/MENU** (9) momentarily to step through the following audio adjustment options: Bass, Treble and Balance (left to right). When the desired option appears in the display, press **VOL+** (7a) or **VOL-** (7b) to adjust that audio feature. When no adjustments have been made for three seconds, the unit will resume normal operation.

### Menu Adjustment

Press **AUDIO/MENU** for more than three seconds to enter menu adjustment mode and adjust any of the menu options: When the desired option appears in the display, press **VOL+** or **VOL-** to adjust that menu option. When no adjustments have been made for three seconds, the unit will resume normal operation. The following menu options may be adjusted using this feature:

- Beep Confirm (On or Off) - Determines if a beep will be heard each time a button is pressed.
- Operation Region (USA or Euro) - Selects the appropriate operating region.
- Clock Display (12 or 24) - Selects a 12-hour or 24-hour clock display.
- Display Brightness (Low, Mid or High) - Determines brightness level of the display.
- Backlight Color (Amber or Green) - Determines the backlight color of the unit.
- Turn On Volume (0-40) - Selects desired volume level for the unit to assume when turned on.
- WB Alert (On or Off) - Determines if the weather band alert feature is activated.



## Tuner Operation

### 10. Select a Band

Press **AM/FM** (10) momentarily to directly access tuner mode from any other function mode. When the unit is already in tuner mode, briefly press **AM/FM** to change between two AM bands (AM1 and AM2) and three FM bands (FM1, FM2 and FM3).

*Note: If the unit is programmed for European operation, the sequence will be MW1, MW2, FM1, FM2 and FM3.*

### 11. Manual Tuning

Press **TUN-** (11a) or **TUN+** (11b) momentarily to tune the frequency one step higher or lower. Press and hold **TUN+** or **TUN-** for more than one second to tune continuously in the selected direction until the button is released.

### 12. Seek Tuning

Press **SEEK-** (12a) or **SEEK+** (12b) momentarily to automatically tune the frequency down or up to the next strong station.

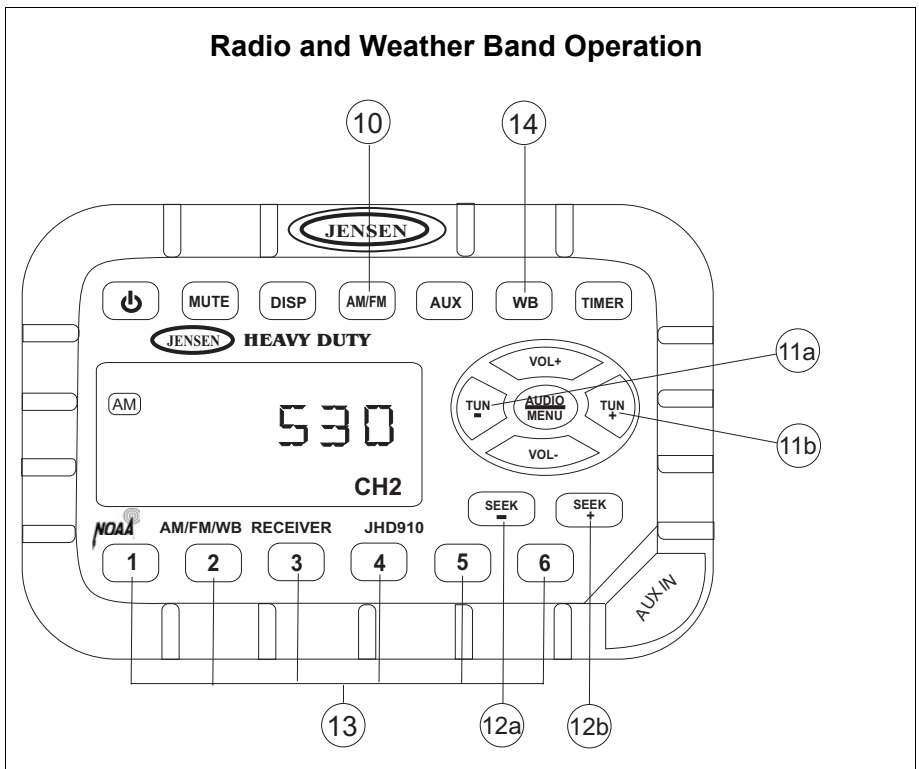



### **13. Preset Stations**

Six numbered preset buttons (13) store and recall stations for each AM and FM band. To store a station, select a band (if needed), then select a station. Hold a preset button for three seconds. The current station will be stored, and the corresponding preset number will appear in the display. To recall a station, select a band (if needed). Press a preset button momentarily, and the unit will tune to the corresponding stored station.

**Note: Preset buttons recall channels 1-6 on weather band and cannot be set by the user.**

## **Weather Band Operation**

### **14. Accessing the Weather Band**

Press **WB** (14) to directly access the weather band mode from any other function mode.

#### What is the NOAA Weather Radio?

This is a nationwide system that broadcasts local weather emergency information 24 hours a day. The U.S. network has more than 530 stations covering the 50 states as well as the adjacent coastal waters, Puerto Rico, the U.S. Virgin Islands and the U.S. Pacific Territories. Each local area has its own transmitting station and there are a total of seven broadcasting frequencies used: 162.400MHz (CH1), 162.425MHz (CH2), 162.450MHz (CH3), 162.475MHz (CH4), 162.500MHz (CH5), 162.525MHz (CH6) and 162.550MHz (CH7).

#### How many stations can I expect to receive?

Since the broadcasts are local weather and information, the transmission power is usually very low (much less than AM or FM stations) so you will usually receive only one station unless you are on the edge of two or more broadcast signals. The most you will receive will be two or three, and that is rare.

#### Is it possible I won't receive any stations?

Depending on location, it's possible you will receive a very weak signal or none at all. Also, similar to AM and FM signals, weather band signals are subject to surrounding conditions, weather, obstructions of the signal by hills or mountains, etc. If no NOAA signals are found/received, the "NO SIG" icon will flash in the display and the tuner will scan all seven NOAA frequencies every 30 seconds.

#### How will I know I am tuned to the weather band?

When you select the weather band, the "WB" icon will appear on the display panel, along with the current channel indication. Press **TUN+** or **TUN-** to tune to each of the seven channels until you find the weather band station broadcasting in your area.

#### NOAA Weather Alert

The Weather Alert function adds an additional level of user safety by automatically switching from the current function mode to weather band mode for a minimum of 60 seconds if a NOAA warning tone (1050 Hz) is received/detected. If no additional warning tone is received for 60 seconds, the unit will switch back to the last known function mode.

The Weather Alert function can be turned "on" or "off" by the Audio/Menu key, as described on page three. When "ON" (default), the Weather Alert icon appears in the display and the weather tuner remains active, even when the radio is turned off (as long as the power is still applied to the radio). If a weather alert is issued, the radio will turn on and play the announcement. for 60 seconds, then turn back off and revert to weather alert monitor mode.

If the Weather Alert function is set to "OFF", no Weather Alert icon appears in the display. The radio will not respond to any weather alerts when it is off and will not automatically switch to the weather band if an alert is issued.

**Note: If the unit is programmed for European operation, the WB function will be disabled.**

## Troubleshooting

<b>Problem</b>	<b>Cause</b>	<b>Corrective Action</b>
No power.	Vehicle ignition switch is not on.	If the power supply is connected to the vehicle accessory circuits but the engine is not moving, switch the ignition key to "ACC".
	The 3A fuse is blown.	Replace the 3A fuse.
No reception	Volume turned down too low.	Adjust volume until sound is heard.
	Wiring not connected properly.	Check wiring connections.
Radio does not work	Antenna cable not connected.	Insert antenna cable firmly.
Volume too high or too low when the radio is turned on	Preset volume is set incorrectly	Use the Menu adjustment (page three) to change preset volume to desired level
LCD display is dark and difficult to read	Radio too hot	Turn radio off and allow to cool down
No WB function	Programmed to "European"	Program to "USA" (setup menu)
Weather alert does not function	Weather alert programmed to "off"	Program to "on" (setup menu)

**Note: Proper care and cleaning is essential to optimal operation. The JHD910 may be cleaned with mild detergent/water mixture and a soft cloth to remove grease and grime. Do not pressure wash directly on the radio.**



## **Specifications**

### General

Power Supply Requirements . . . . . DC 12 Volts, Negative Ground  
 Chassis Dimensions . . . . . 131.6 (W) x 47.5 (D) x 86 (H)  
 Loading Impedance . . . . . 4 -8 ohms per channel  
 Tone Controls . . . . . Bass (at 100 Hz), ±10 dB; Treble (at 10 kHz), ±10 dB  
 Current Drain . . . . . 1.5 Ampere (max)

### FM Tuner

Tuning range . . . . . 87.5-108.0  
 FM mono sensitivity . . . . . 1.5uV  
 Stereo separation @ 1 kHz . . . . . >25dB

### AM Tuner

Tuning range . . . . . 522-1710  
 Sensitivity . . . . . <30uV

### Weather Band

Sensitivity . . . . . <1uV

### Amplifier

Total system power . . . . . 15 Watts Maximum  
 Signal to Noise . . . . . >70dB

**Specifications subject to change without notice.**

**Note: The manufacturer is not responsible for any radio or TV interference caused by unauthorized modifications to this equipment. Such modifications could void the User's authority to operate the equipment.**

**This device complies with Part 15 of the FCC rules. Operation is subject to the following two conditions:**

- 1) This device may not cause harmful interference, and**
- 2) This device must accept any interference received, including interference that may cause undesired operation.**



www.asaelectronics.com  
 © 2006 ASA Electronics Corporation  
 v.100506