

Voyager[®]

AOM-711

7" FLAT PANEL COLOR OBSERVATION MONITOR OWNER'S MANUAL

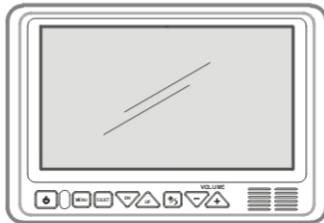

AOM-711 Features:

- High Performance Automotive Grade 7" Color LCD Panel
- 2 Camera Inputs
- PAL / NTSC Compatible
- DC Auto Source Switching Triggers (Turn Signal Compatible)
- Backlit Control Buttons
- Built-In Audio Speaker
- Compatible with Voyager Standard Camera
- Manual/Auto Day/Night Display Brightness Modes
- Programmable Source Name OSD

Camera-Monitor Warnings!

1. Camera/monitor system aids in the use of, but does not replace vehicle side/rear-view mirrors.
2. Objects in camera/monitor view are closer than they appear.
When backing up, proceed cautiously and be prepared to stop.

AOM-711

Important! - Please Read This Manual Before Installing!

Congratulations on your purchase of a Voyager AOM711 LCD Observation Monitor. With proper installation and use, your AOM711 LCD is designed to provide you with years of trouble-free operate the unit. Please read this manual thoroughly beginning.

All Voyager Observation products are strictly intended to be installed as supplement aid to standard rear-view mirror systems that may already exist in your vehicle. Voyager Observation products are not intended for use as substitutes for-view mirror devices, Or for any other standard motor vehicle equipment required be installed on vehicles by law.

While Voyager observation products contribute to improving the vehicle operator's field Of view, these products are no substitute for proper defensive driving techniques and Observance of traffic laws and motor vehicle safety regulations.

Warnings!

RED POWER WIRE MUST BE CONNECTED TO ACCESSORY TO AVOID CURRENT DRAW IN THE KEY OFF POSITION.

Installation Location

It is unlawful in most jurisdictions for a person to drive a motor vehicle equipped with a television viewer or screen located at any point forward of the back of the driver's seat or in any location that is visible, directly or indirectly, to the driver while operating the vehicle. The AOM711 product is designed to be used primarily as a rear observation device in conjunction with closed circuit camera. In any installations where the AOM711 is used to display television broadcasts or recorded video, playback, installation location must adhere to local laws and regulations.

Tampering

To prevent electrical shock, DO NOT OPEN THE MONITOR CASE. *There are potentially harmful voltages inside the monitor. There are no user serviceable parts inside.* If evidence of tampering is detected, the warranty will be considered void.

Moisture

While it will withstand short periods of exposure to moisture, this product does contain sensitive electronic components and exposure to moisture should be limited by the user/installer. This product is not designed for where constant exposure to moisture or immersion can be encountered. This unit should NEVER be cleaned with a power washer or used where direct power washer spray may be encountered.

Depth of view

OBJECTS VIEWED IN MONITOR ARE CLOSER THAN THEY APPEAR.

AOM-711

PACKING CONTENTS

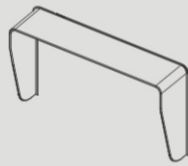

SUN SHIELD
QTY. 1

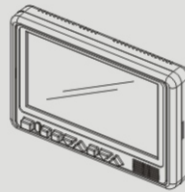

LCD MONITOR
QTY. 1

CABLE QTY. 1

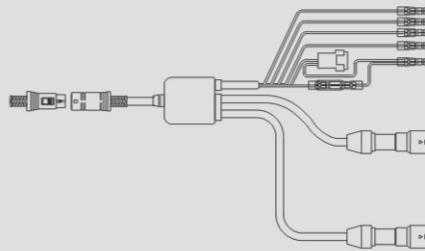

P/H Machine Screw
M4X10mm
QTY. 4



4" BLACK WIRE TIE
QTY. 1

AOM-711

CONTROLS AND OPERATION

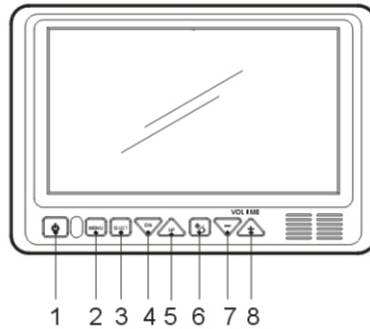

1. POWER ON/OFF



- Press once turns unit on
- Press again turns unit off
- When power applied and unit is off, only the red power button is backlit.
- When unit is turned on, all buttons are backlit.

2. MENU



- Each one press less than 1 second enters brightness, contrast, color or tint adjust mode in turns (See Fig.1)
- Time out of OSD menu is approx. 5 seconds from last key pressed

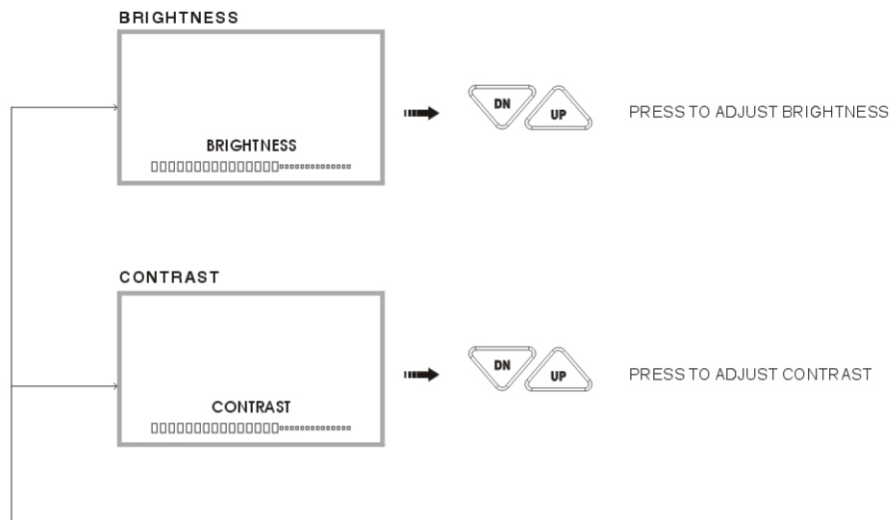

AOM-711

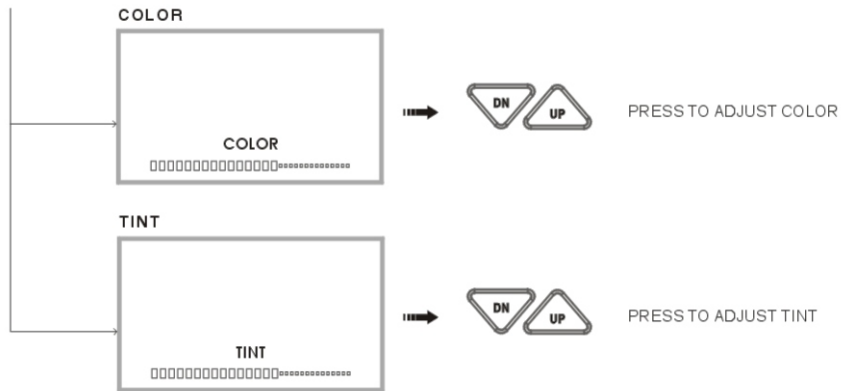

Fig.1 Brightness, contrast, color and tint control



-Press menu button over 2 seconds enters setup menu (See Fig.2)
 -Press again before time out exits menu mode

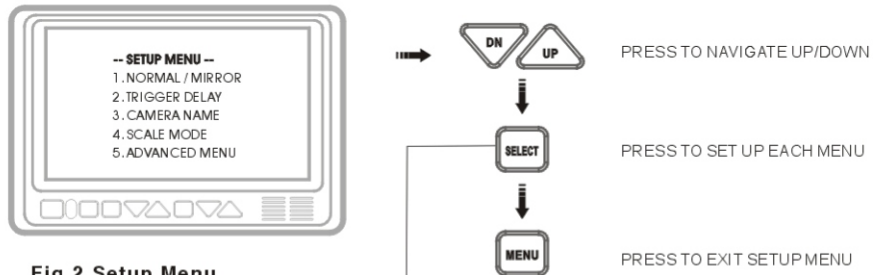
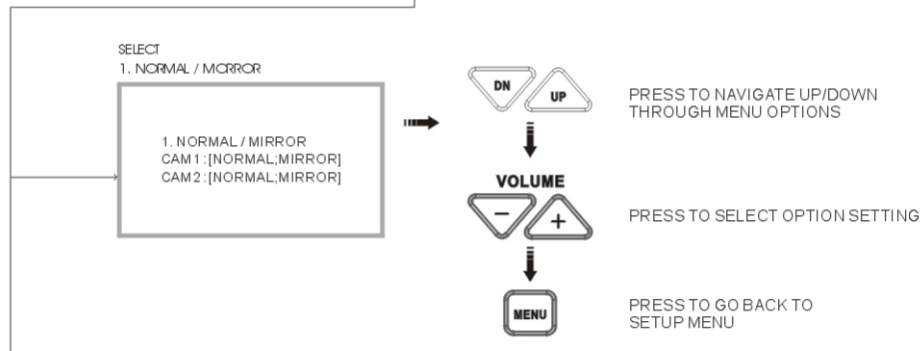
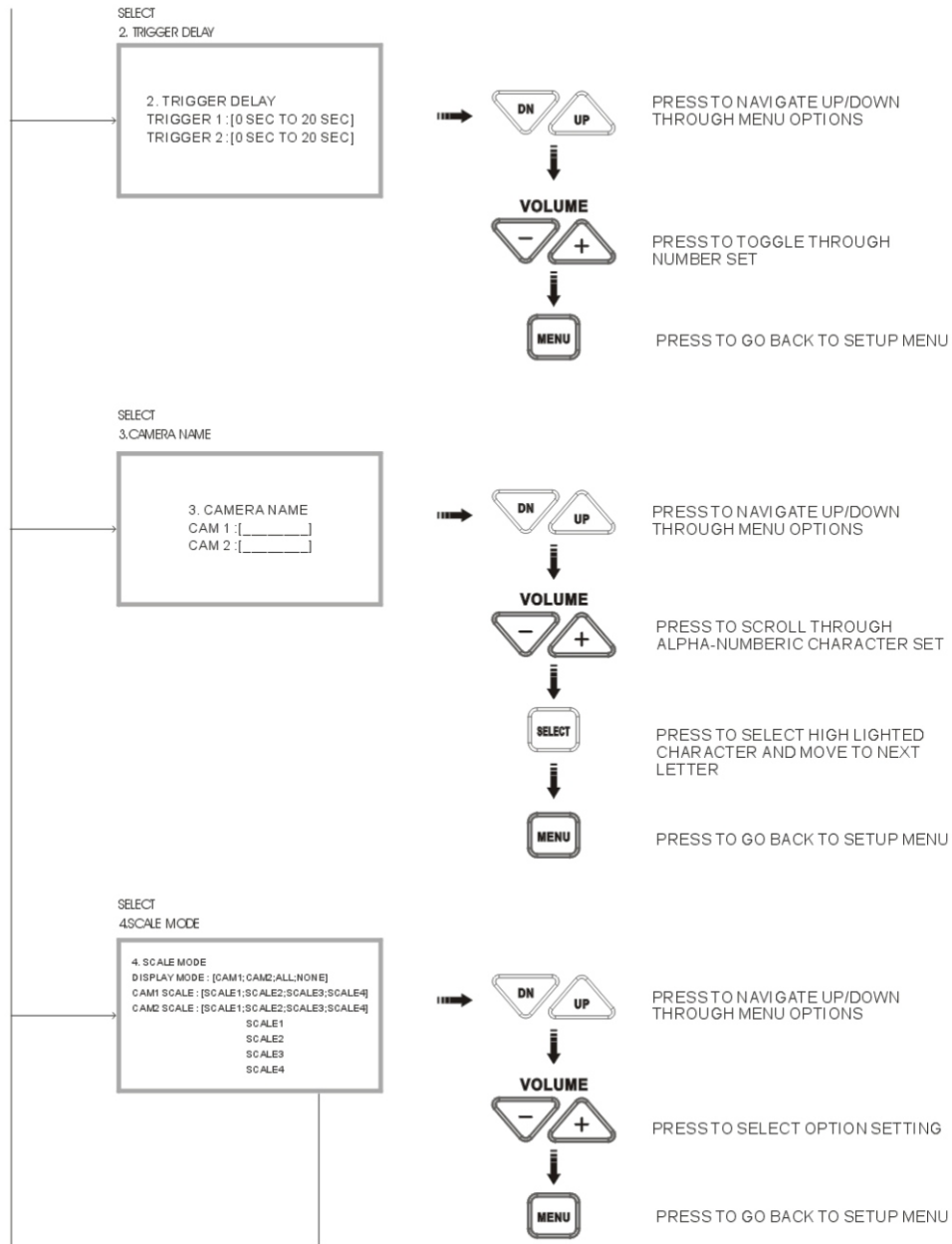

Fig.2 Setup Menu



AOM-711



AOM-711

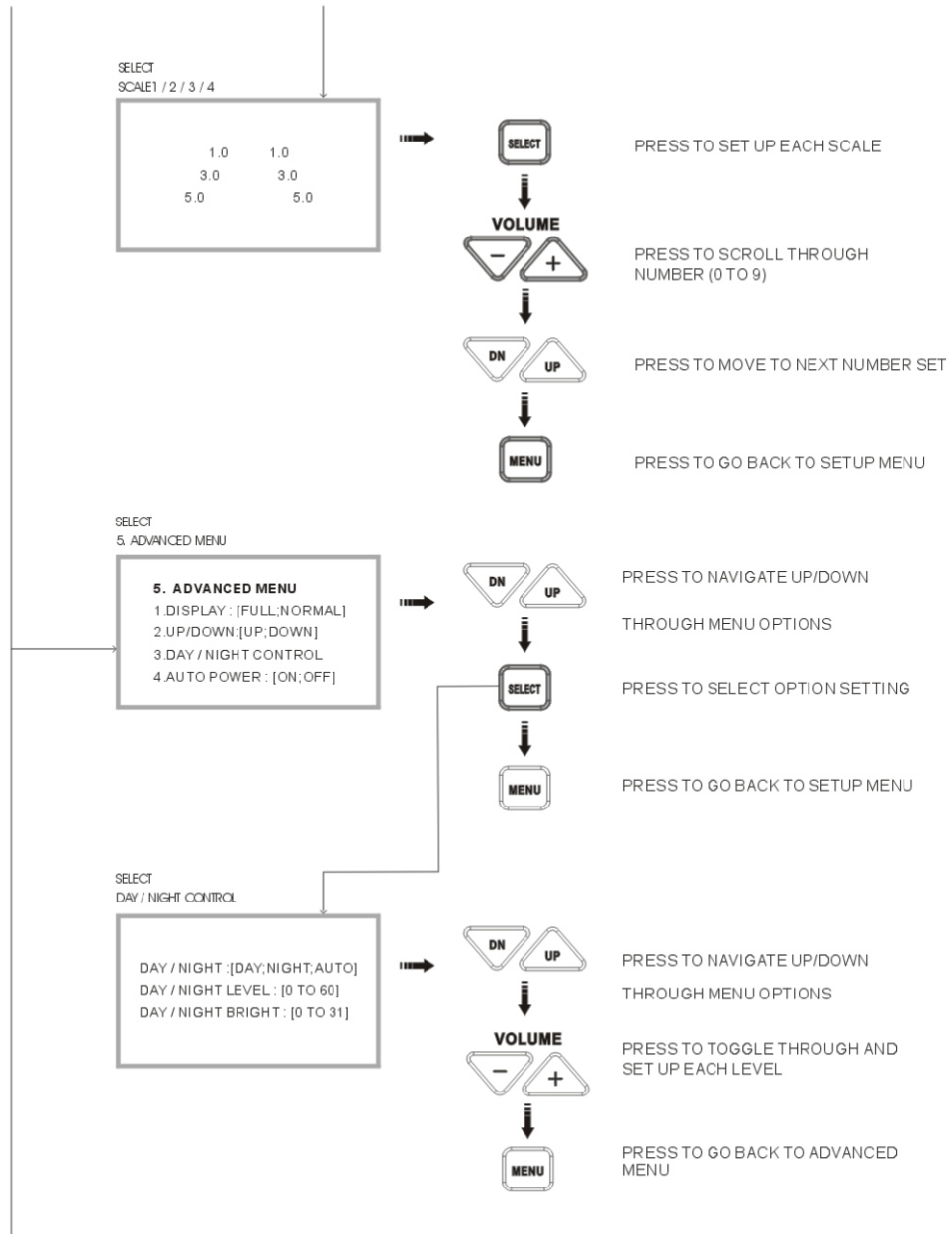

AOM-711

3. SELECT



Primary Function Input Source Select

-Pressing "SELECT" button sequences source input modes from CH1 to CH2.

-Source ID is indicated by OSD in top left corner.

Secondary Function Menu Option Selection

-While in Menu mode, the "SELECT" button is used to select the highlighted function or option setting

4. UP / DOWN



Primary Function Brightness, Contrast, Color and Tint Control

-Pressing "UP" button increases brightness, contrast, color or tint level

-Pressing "DN" button decreases brightness, contrast, color and tint level

Secondary Function Menu Navigation

-While in Menu modes, the "UP" and "DN" buttons are used to move cursor upward or downward

5. Day / Night



Primary Function DAY/NIGHT Mode Setting

-Pressing "DAY/NIGHT" button sequences day/night backlight compensation through "DAY", "NIGHT" and "AUTO" modes

6. Volume +/-



Primary Function Speaker Volume Control

-Pressing "-" button decreases speaker volume.

-Pressing "+" button increases speaker volume.

Secondary Function Menu Option Setting Selection

-While in certain Menu modes (i.e. Source Naming), the "-" and "+" buttons adjust settings or navigate through the available menu settings.

AOM-711

INSTALLATION INSTRUCTIONS

BEFORE YOU BEGIN INSTALLATION:

Before drilling be sure that no cable or wiring is on the other side. Clamp all wires securely to reduce the possibility of them being damaged during installation and use.

Keep all cables away from hot or moving parts, and electrically noisy components.

Wiring Definitions:

- Power connection:

Pin 1	POWER IN DC (10.5V~ 32V) -Red
Pin 2	GROUND -Black
Pin 3	CHANNEL 1 TRIGGER -Blue
Pin 4	CHANNEL 2 TRIGGER -Brown
Pin 5	AUDIO/MUTE (AUDIO ON/OFF) -White
Pin 6	DAY/NIGHT TRIGGER - Gray

- Camera 1 input: 4-Pin Connection for camera or camera extension cable
- Camera 2 input: 4-Pin Connection for camera or camera extension cable
- LCD panel: 13-Pin Large DIN cable connection to monitor

General:

1. Choose the monitor, and camera locations.

2. Install all required cables in vehicle. A 3/4" (19mm) hole should be drilled for passing camera cables through vehicle walls, barriers, etc. Install split grommets where applicable. If additional cable protection is required install convoluted tubing over the cable.

3. After cable/wiring has been routed and components in place, temporarily make all system connections and perform a system function check. If system does not operate properly, see the troubleshooting section cable.

4. Make sure all cables are routed away from hot or moving parts, and away from sharp edges. Secure cables with wire ties.

Backup (Rear) Camera

- Rear-mounted cameras used for monitoring while backing up must be connected to the CA1 input. Trigger#1 must be connected to the reverse gear light circuit in the vehicle.

Side Camera

- If side monitoring camera is installed, it should be connected to CA2. Trigger 2 should be connected to the vehicle's turn signal circuits.

AOM-711

TYPICAL SYSTEM CONNECTION

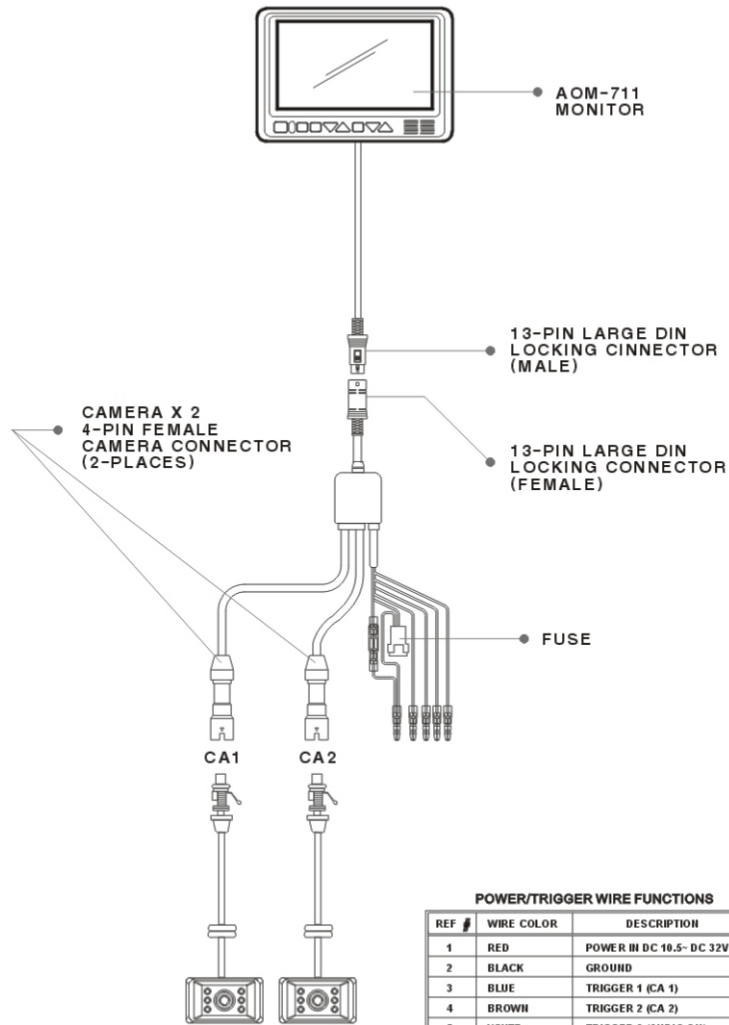

AOM-711

PRODUCT SPECIFICATIONS

LCD PANEL SPECIFICATIONS

Size/Type	7" (DIAGONAL) TFT LCD	
Brightness	500 cd/m ² (max)	
Contrast Ratio	300 (max)	
View Angles	Top (12 o'clock)	50° (min)
(@ CR ≥ 10)	Bottom (6 o'clock)	70° (min)
	Horizontal	±70° (min)
Response Time	Rise : 12 ms (typ) ; 24ms (max)	
	Fall : 18 ms (typ) ; 36ms (max)	
Back Light Type	CCFL	
Back Light Life	10,000 hrs (min)	

- **Operation Temperature Range** : -20 °C ~ +65 °C
- **Storage Temperature Range** : -35 °C ~ +85 °C
- **Max Humidity** : 85%
- **Operation Voltage Range** : DC 10.5V ~ 32V
- **Current Draw (typical)** : Max 15W
- **Signal system** : NTSC or PAL (Auto detection)
- **Video Aspect Ratio** : 16 : 9
Input Level : 1Vp-p 75Ω
- **Audio Input Level** : Max 0.2 W-150mV
- **Product Weight** : 1.43 lbs / 650Kg
- **Product Dimensions** : Monitor Only Dimensions
7.75 W X 5.25 H X 1.25D inches



AUDIOVOX SPECIALIZED APPLICATIONS, L.L.C.

www.asaelectronics.com

Printed in Korea