



MA100

Owner's Manual



CONTENTS

Introduction.....	1
Features	1
Box Content.....	1
Compliance	1
Safety Information	2
Installation	3
Mounting the Radio.....	3
Auxiliary Input	4
Line Output.....	4
Wiring Diagram.....	5
Operation.....	6
Basic Functions	6
Audio Menu	6
Radio Mode	6
USB Mode.....	7
Auxiliary Input Mode	7
Bluetooth Operation.....	8
App Operation	10
Troubleshooting	11
Specifications	12

INTRODUCTION

Thank for choosing a MARINE AUDIO product. We hope you will find the instructions in this owner's manual clear and easy to follow. If you take a few minutes to look through it, you'll learn how to use all the features of your new MARINE AUDIO receiver for maximum enjoyment.

Features

- Waterproof iPx6
- UV and Corrosion Resistant
- AM/FM Tuner
- 12 Programmable Presets (6 AM, 6 FM)
- USB MP3/WMA Player
- Rear Auxiliary Audio Output
- 4-Channel Amplified Audio Output
- Bluetooth (Supports A2DP and AVRCP)
- APP Ready

Box Content

- MA100 Radio
- Radio Mounting Bracket
- Screw Posts (x2)
- Locking Hex Nuts (x2)
- Washers (x2)

Compliance with FCC Rules

NOTE: This equipment has been tested and found to comply with the limits for a Class B digital device, pursuant to Part 15 of the FCC Rules. These limits are designed to provide reasonable protection against Harmful interference in a residential installation. This equipment generates uses and can radiate radio frequency energy and, if not installed and used in accordance with the instructions, may cause harmful Interference to radio communications.

However, there is no guarantee that interference will not occur in a particular installation. If this equipment does cause harmful interference to radio or television reception, which can be determined by turning the equipment off and on, the user is encouraged to try to correct the interference by one or more of the following measures:

- Reorient or relocate the receiving antenna.
- Increase the separation between the equipment and receiver.
- Connect the equipment into an outlet on a circuit different from that to which the receiver is connected.
- Consult the dealer or an experienced radio/TV technician for help.

NOTE: THE MANUFACTURER IS NOT RESPONSIBLE FOR ANY RADIO OR TV INTERFERENCE CAUSED BY UNAUTHORIZED MODIFICATIONS TO THESE EQUIPMENT.SUCH MODIFICATIONS COULD VOID THE USER'S AUTHORITY TO OPERATE THE EQUIPMENT.

Compliance with FCC Rules (U.S.A. Only)

This device complies with Part 15 of the FCC rules. Operation is subjected to the following two conditions: (1) This device may not cause harmful interference, and (2) this device must accept any interference received, including interference that may cause undesired operation.

FCC WARNING

- Changes or modifications to this unit not expressly approved by the party responsible for compliance could void the user's authority to operate the equipment.
- Proper connections must be used for connection to a host computer and/or peripherals in order to meet FCC emission limits.

Safety Information

- To ensure full satisfaction with the product, please read the entire instruction manual.
- Keep instructions for future reference.
- Follow all operation guidelines and adhere to all safety warnings and cautions to ensure safe use.
- Do not install near any heat sources such as radiators, heat registers, stoves, or other apparatus (including amplifiers) that produce heat.
- Only use attachments/accessories specified by the manufacturer.
- Never use harsh cleaning agents. Clean only with a dry cloth.

When Driving

Keep the volume level low enough to be aware of the road and traffic conditions.

Protect from Water

Do not submerge, as this can cause electrical shorts, fire or other damage.

Protect from High Temperatures

Exposure to direct sunlight for an extended period of time can produce very high temperatures inside your vehicle. Give the interior a chance to cool down before starting playback. Do not mount the radio within close proximity of the engine compartment.

Use the Proper Power Supply

This product is designed to operate with a 12 volt DC negative ground battery system.

WARNING:

- DO NOT OPEN, DISASSEMBLE OR ALTER THE UNIT IN ANY WAY. Doing so may result in fire, electric shock or product damage.
- USE THE CORRECT AMPERE RATING WHEN REPLACING FUSE. Failure to do so may result in fire, electric shock or product damage.
- DO NOT INSTALL IN LOCATIONS THAT MIGHT HINDER VEHICLE OPERATION. Doing so may obstruct vision or hamper movement which can result in a serious accident.
- INSTALL THE WIRING SO THAT IT IS NOT CRIMPED OR PINCHED BY SCREWS OR SHARP METAL EDGES. Route the cables away from moving parts or sharp pointed edges. This will prevent crimping and damage to the wiring. If the wiring must pass through a metal hole, be sure to use a rubber grommet to prevent the wire's insulation from being cut by the metal edge of the hole. It is also recommended to apply sealing caulk to any opening that may potentially allow water to enter.
- Be sure to choose a location that is flat and has clearance above the unit to prevent any damage, as well as allow for ventilation.
- Before drilling any holes, carefully inspect the area underneath and behind the mounting surface where the device will be mounted to make sure it will not interfere with existing wires, fuel lines, the fuel tank or any other objects that could be damaged.
- Always disconnect the vehicle negative battery terminal during installation to prevent accidental shorting.

INSTALLATION

Mounting the Radio

1. Choose a mounting location on the dash board or instrument panel that will allow room behind to run radio cables to the power source. Consider how you will use the AUX IN, LINE OUT and USB connectors and route the appropriate extension cables to an accessible area.
2. Cut a hole in the dash board using the template provided in the back of this manual. At least 3 3/4" depth is needed to mount the radio.

IMPORTANT! Do not mount this unit where it can be submerged in water.

3. Slide the included spring washers (B) over the screw posts (A) and attach the screw posts to the back of the radio.
4. Place the radio in front of the dashboard opening so the wiring can be brought through the opening.
5. After completing the wiring connections, turn the radio on to confirm operation (vehicle accessory switch must be on). If the radio does not operate, recheck all wiring until the problem is corrected. Once proper operation is achieved, turn the accessory switch off and proceed with final mounting of the radio. Refer to the "Wiring Diagram" on page 5.

NOTE: Before final installation, test the wiring connections to make sure the unit is connected properly and the system works.

6. Insert the radio into the mounting hole.
7. Place the "U" bracket (C) over the screw posts and secure the radio to the dash using the included hex nuts (D). If necessary, cut the score marks (E) on either side of the mounting bracket to custom fit the bracket length for your application. See Figure A.

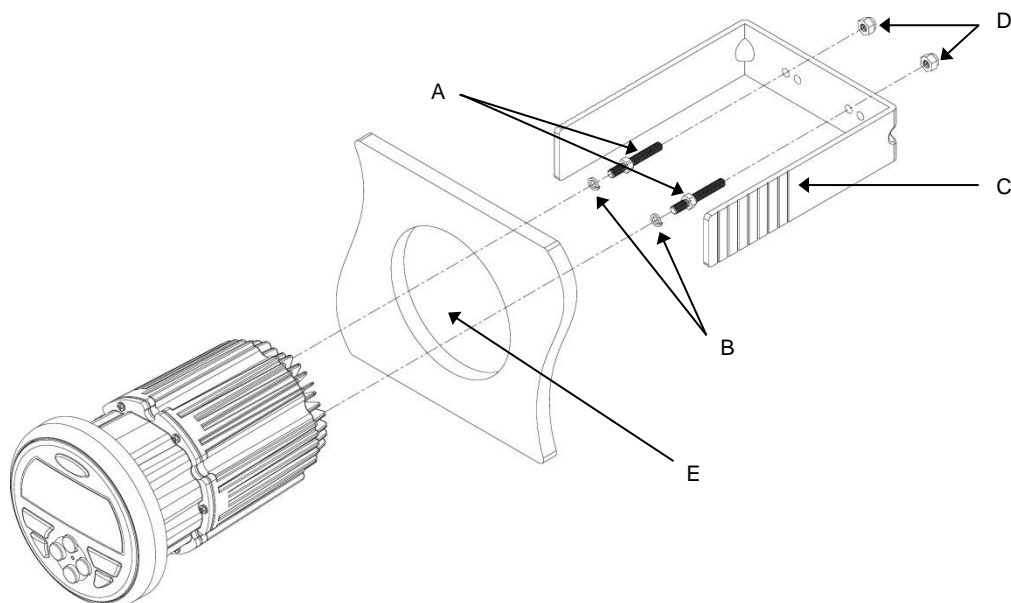

Figure A - Installation

Auxiliary Input

Connect a portable audio device to the Audio Input (AUX IN RIGHT/LEFT) on the back of the unit using RCA cables.

Line Output

The Line Out connectors (LINE OUT RIGHT/LEFT) on the back of the unit output a line-level analog signal. Use this output to connect to an external amplifier

Wiring Diagram

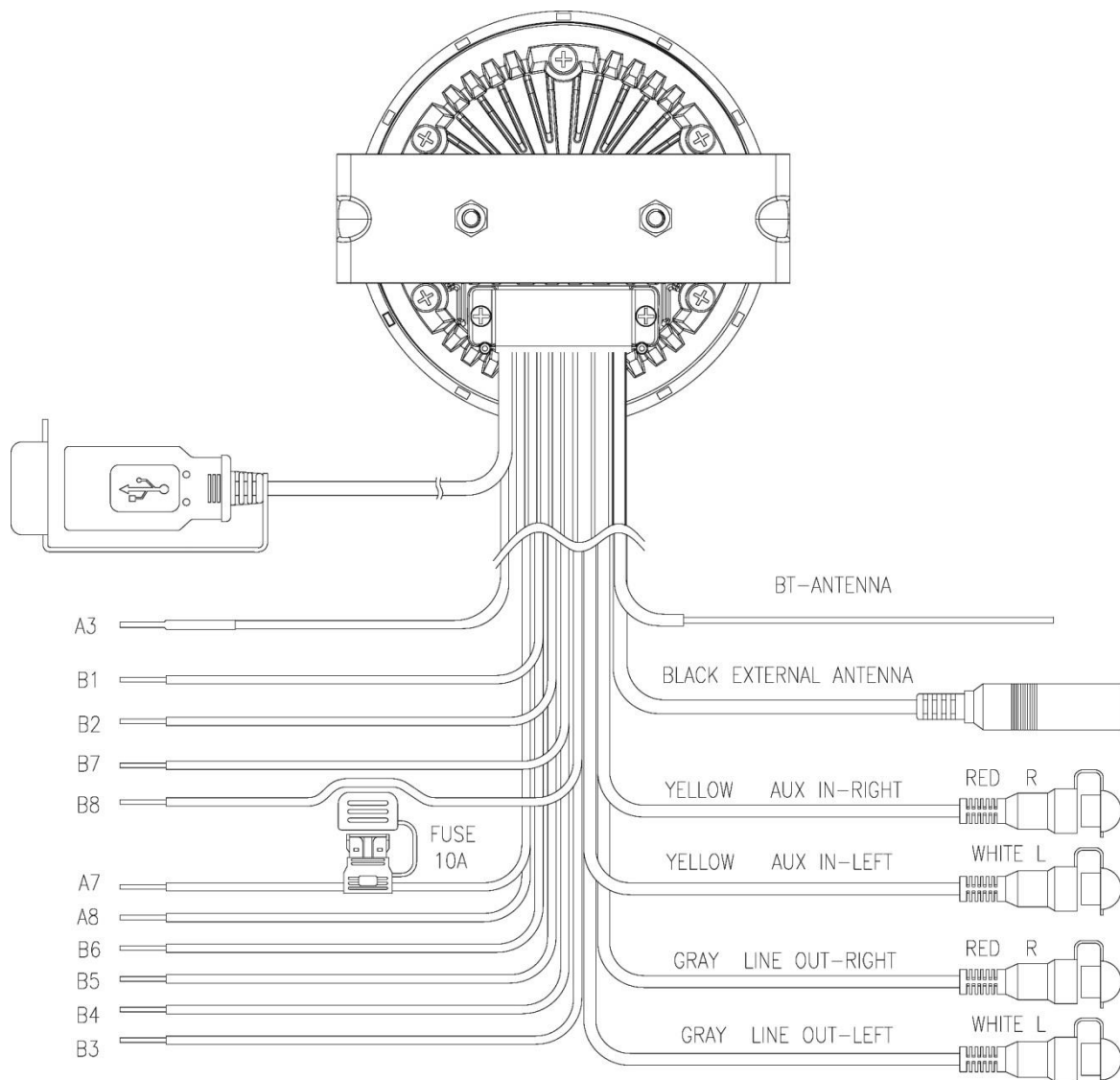

PIN NO.	WIRE COLOR	DESCRIPTION
B1	PURPLE	RIGHT REAR SPEAKER (+)
B2	PURPLE/BLACK	RIGHT REAR SPEAKER (-)
B7	GREEN	LEFT REAR SPEAKER (+)
B8	GREEN/BLACK	LEFT REAR SPEAKER (-)
A3	BLUE	POWER AMP REMOTE
A8	BLACK	GROUND
A7	RED	ACC +12V
B3	GRAY	RIGHT FRONT SPEAKER (+)
B4	GRAY/BLACK	RIGHT FRONT SPEAKER (-)
B5	WHITE	LEFT FRONT SPEAKER (+)
B6	WHITE/BLACK	LEFT FRONT SPEAKER (-)

Note: Do not connect the red wire to a constant power connection. The red wire should be connected to a vehicle connection with switched power such as IGN or ACC.

OPERATION

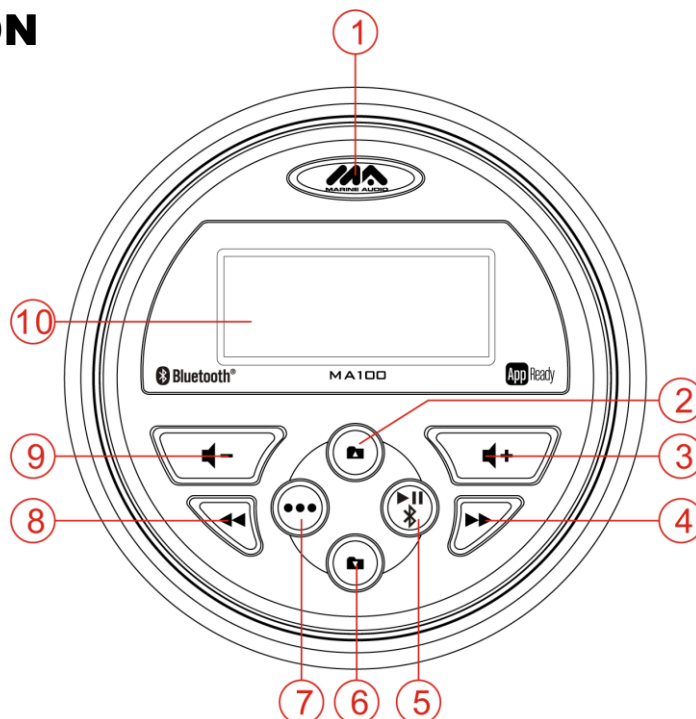

Basic Functions

Power

Press the **MARINE AUDIO** power button (1) to turn the unit on/off.

Restore Factory Settings

Perform the following steps to reset the radio to factory default settings:

1. Press and hold the power button (1) to display the software version.
2. Press the **▲+** button (3) to display "RESET".
3. Press the power button to confirm factory default restore. After reset, the unit will default to FM mode.

Volume

Press the **▲+** button (3) to increase the volume.

Press the **▲-** button (9) to decrease the volume.

Press and hold either button to change the volume level quickly.

Mute

Press the **||/X** button (5) to silence the audio output in tuner, AUX or USB mode. Press again to restore the previous volume level.

Mode

Press the **...** button (7) to select a mode of operation: FM, AM, AUX, USB and Bluetooth.

Audio Menu

Press and hold the **...** button (7) to access the audio menu. Press the **...** button repeatedly to adjust the following settings: BASS, TREBLE, BALANCE, FADER, AS and PS. Use the **▲+ / ▲-** buttons (3, 9) to choose a value for each setting. See "Radio Mode" for instructions regarding the Auto Store (AS) and Preset Scan (PS) features.

Radio Mode

USA/Europe (EURO) Tuning Mode Selection

To change from USA to European tuning mode, perform the following steps:

1. Press and hold the **...** button (7) for 2 seconds to access the system menu.
2. Press the **...** button repeatedly to move through the menu options (BASS > TREBLE > BALANCE > FADER > AS/PS > USA/EURO). The unit will display USA (if set to USA frequency tuning mode) or EURO (if set to European frequency mode).
3. With the display showing the current tuning mode, press the **▲-** or **▲+** button (9, 3) to change between USA/EURO.
4. Press the **MARINE AUDIO** power button (1) to confirm your selection.

Frequency Tuning



Press the ◀◀ or ▶▶ button (8, 4) to fine tune the radio frequency.

Channel Seek



Press and hold the ◀◀ or ▶▶ button to seek strong radio frequencies.

Preset Channel Store



To manually store a favorite channel to one of the six preset channels, perform the following steps:

1. Press the ◀◀ or ▶▶ button (8, 4) to tune to the radio frequency you want to store.
2. Press and hold the  or  button (2, 6) to access the preset channel list.
3. Press the ◀◀ or ▶▶ button to select the desired preset channel number (1-6).
4. Wait three seconds and the unit will save the station to the chosen preset channel and display "SAVED" on the screen.



Auto Store

Press and hold the  button (7) to access the audio menu. Press the  button repeatedly until "AS" appears on the display. Press the ▶▶ button to begin the Auto Store function and store the strongest stations to the preset tuning channels. The unit will automatically perform a Preset Scan once the Auto Store is complete.

Preset Scan

Press and hold the  button to access the audio menu. Press the  button repeatedly until "PS" appears on the display. Press the ▶▶ button to begin the Preset Scan function and listen to a preview of each stored station.

Preset Channel select

Press the  /  buttons (2, 6) to select available preset channels.

USB Mode

Insert/Remove USB Device

You can connect a USB device directly to the USB interface at the rear of the radio for playback of compatible files. Playback begins automatically.

Press the  button (7) to switch to USB mode from another source.



Play/Pause (USB)

During USB playback, press the  button (5) to play or pause the selected track.

Next/Previous File

Press the ◀◀ or ▶▶ button (8, 4) to select the previous or next track.

Folder Navigation

Press the buttons  /  (2, 6) to select the next/previous folder. Playback will begin with the first song file in the selected folder.

Fast Forward/Fast Reverse

Press and hold the ◀◀ or ▶▶ button to fast forward or fast reverse.

Auxiliary Input Mode

Press the  button (7) to directly access auxiliary input mode (AUX IN) from any other mode when a portable audio device is connected to the unit.

Bluetooth Operation

The MA100 includes built-in Bluetooth technology that allows you to connect this head unit to Bluetooth-enabled devices for streaming audio playback.

About Bluetooth Technology

Bluetooth wireless technology is a short-range wireless radio protocol. Operating in the 2.4 GHz range, it transmits audio and data at speeds up to 2.1 Mbit/s over a range of up to 10 meters.

Bluetooth Menu Options

NOTE: Please note that some Bluetooth menu options are only available while the unit is in Bluetooth Audio mode.

Press and hold the **•••** button (7) to enter the menu adjustment mode. Then repeatedly press the **•••** button to access the following Bluetooth Menu options:

- BT ON/OFF: Press the **◀+ (ON)** or **◀- (OFF)** buttons (3, 9) to turn the Bluetooth function on or off.
- BT Pair: On the BT Pair screen press the **▶ || / ✕** button (5) to make pairing available for 120 seconds then connect using your Bluetooth enabled device
- DEVICE: Press the **▶ || / ✕** button to view a list of previously paired mobile phone devices. Press the **◀+ or ◀-** buttons (9, 3) to view devices in the list. When viewing a specific device press **▶ || / ✕** again to enable the following LOCK/UNLOCK, DISCONNECT, and DELETE functions and **◀+ or ◀-** to cycle through them.
 - LOCK/UNLOCK: The MA100 can store up to 5 devices for Bluetooth connection. The devices are stored in a FIFO (First In First Out) order. To prevent a device from being bumped from the list when more than 5 devices are used, you can lock the device. To Lock/Unlock a device, press **▶ || / ✕** to change between Lock/Unlock.
 - DISCONNECT: To disconnect a paired device, press the **▶ || / ✕** button to temporarily remove the Bluetooth connection. The connection can be re-established through your phone menu by selecting the MA100 for connection.
 - DELETE: Deleting a device removes it from the pairing list. To delete a device from the list, press the **▶ || / ✕** button. To reconnect with a deleted device it must be paired again.

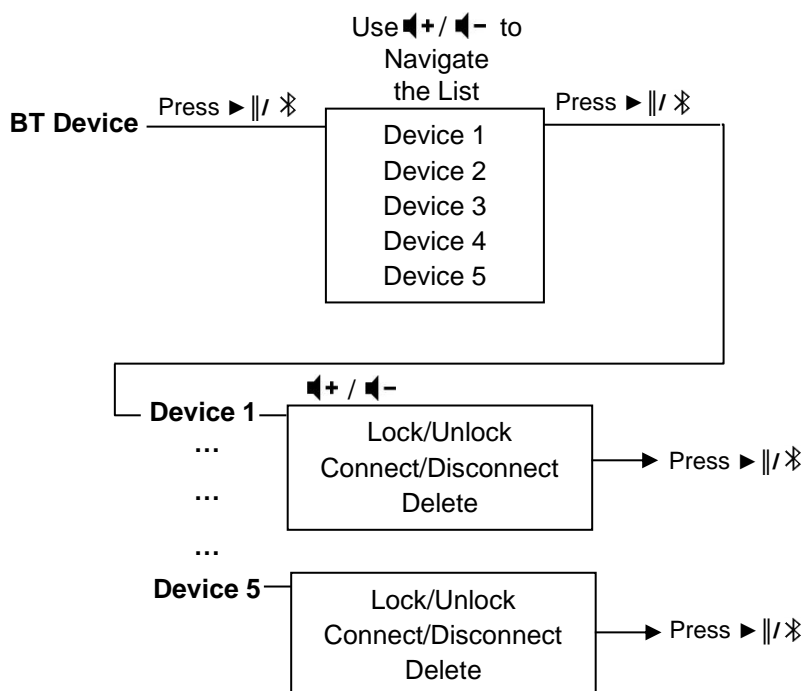

Pairing a Bluetooth Device

Before you begin, consult the owner's manual for the Bluetooth device you want to pair with the MA100. If you are having difficulty putting the MA100 into pairing mode, check to make sure the MA100 Bluetooth (BT) is ON in the system menu. BT is ON by default.

Bluetooth Quick Pair (Newer revisions only, Rev. E or later):

1. On your personal Bluetooth device, enter the Bluetooth settings list. Make sure your device has Bluetooth turned on and is searching for new devices.
2. Press **•••** button (7) repeatedly until the MA100 is in Bluetooth mode.
3. *Press and hold* the **▶||/⌘** button (5) for three seconds to make the MA100 available on your Bluetooth device.
4. On your Bluetooth device, select **MA100** once it becomes available to pair and connect your device.
Enter the pairing password (0000), if requested.

Note: You can alternatively pair from the System Menu while in Bluetooth Mode.

Bluetooth System Menu Pair (All revisions):

1. On your personal Bluetooth device, enter the Bluetooth settings list. Make sure your device has Bluetooth turned on and is searching for new devices.
2. Press **•••** button (7) repeatedly until the MA100 is in Bluetooth mode.
3. *Press and hold* the **•••** button to enter the system menu.
4. Repeatedly press **•••** until the unit displays PAIR ON, then press **▶||/⌘** to make the MA100 available on your Bluetooth device.
5. On your Bluetooth device, select **MA100** once it becomes available to pair and connect your device.
Enter the pairing password (0000), if requested.

After connecting successfully, you will be able to listen to audio from your Bluetooth enabled device through the MA100.

Answering a Call

When answering a call using the connected phone, Bluetooth audio playback will pause. After hanging up from the call, Bluetooth audio will continue on some phones. It may be necessary to press the play button to resume Bluetooth audio playback.

Bluetooth Audio (A2DP)

Selecting Tracks

During playback, press **◀◀** (8) or **▶▶** (4) to play the previous or next track.

Pausing Playback

During playback, press **▶||/⌘** (5) to pause the Bluetooth audio playback. "BT AUDIO PAUSE" will appear on the LCD. Press **▶||/⌘** again to resume playback. If you change to another mode, the mobile device audio will pause. Press the **•••** button (7) to return to Bluetooth mode and resume mobile device audio playback.

NOTE: If a Bluetooth device is disconnected due to the power being turned off or if the device goes out of range, the unit will automatically search for the matching Bluetooth mobile device when the power is restored.

APP OPERATION

MARINE AUDIO® Specialty Controller is the ultimate wireless remote control for your MARINE AUDIO stereo system. Store away your old remotes and enjoy the convenience of all the primary functions of your MARINE AUDIO stereo right from your phone or tablet by transforming your mobile device into a functional stereo remote control!

Features

This app controls all of the primary functions of your stereo features including:

- Power on/off
- Volume and mute
- AM/FM radio tuner: access station, recall, store presets, switch songs
- Bluetooth® streaming audio
- File structure visibility, track selection, track audible scan up and down via USB
- Auxiliary audio input control –auxiliary analog 1
- Audio menu controls- bass, treble, balance, fader and volume settings
- Visual display feedback so you can see artist title and album on your mobile screen

Connecting and using Marine Audio app

After downloading and installing **Marine Audio app** on your device, pair your device to the MA100 as stated above for Bluetooth pairing.

When MARINE AUDIO is installed on Android operating system, close the app before Bluetooth pairing, otherwise there may be errors on Bluetooth connection.

TROUBLESHOOTING

Table 1: Troubleshooting

Problem	Solution
No power	If the power supply is connected to the vehicle accessory circuits but the engine is not on, switch the ignition key to "ACC"
	Fuse may be blown. Replace with 10AMP ATO fuse.
No AM/FM Reception	Antenna cable not connected; insert antenna cable firmly.
No sound	Check volume level; increase volume if necessary.
	Check power; make sure device is on.
	Check device; press the play/pause button to ensure unit is not in Pause mode.

SPECIFICATIONS

General

Frequency band(s) (for Bluetooth)	2.4~2.4835GHz
Maximum radio-frequency power transmitted (for Bluetooth)	4 dBm
Power Supply Requirements	DC 12 Volts, Negative Ground
Operating Voltage	10-16VDC
Unit Dimensions	3.543" Diameter, 5.354" Deep
Mounting Dimensions	3.866" Wide, 6.299" Deep
Weight	1 lb.

FM Tuner

Tuning Range	87.5 to 107.9 MHz
Sensitivity	<4 μ V
Stereo Separation @1 kHz	>25 dB

AM Tuner

Tuning Range	530-1710 KHz
Sensitivity	<63 μ V

Amplifier

Max Output Power	160 Watts Total (40 Watts, 4 Channel)
Output Impedance	Compatible with 4-8 Ohm Speakers, 4 Ohm Load Minimum

Specifications subject to change without notice.



www.asaelectronics.com

v. 161017

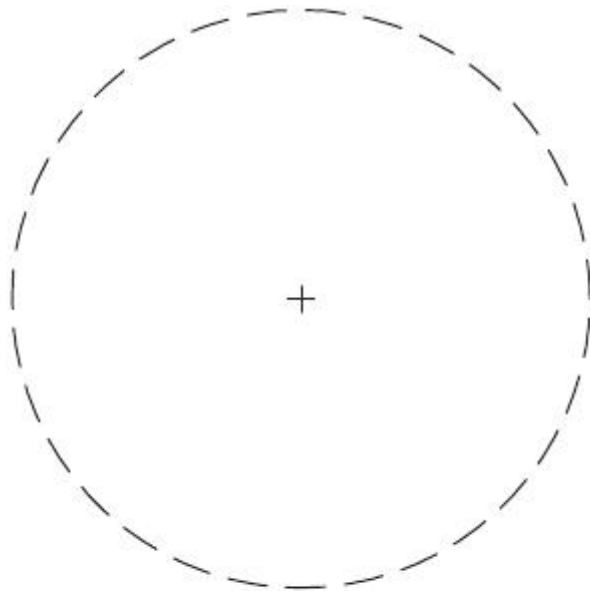

**3" Cutout
Template**